

ATRO



ATRO Polyurethane Torque Rods

ATRO Polyurethane Torque Rods are designed with uptime in mind. ATRO's unique rotating bushing allows the inner pins to rotate 360° which eliminates bushing wind up- the leading cause of bushing failure.

Polyurethane is impervious against oil, grease, brine, cleaning solvents, hydraulic fluid and diesel fuel allowing 3-5x longer life than it's rubber counterparts.

With ATRO behind you, drive forward.

Visit Our Website (<https://atrobushing.com/default>)

ATRO Torque Rod Finder (<https://atrobushing.com/atro-torque-rod-finder>)

ATRO: Freightliner Catalog (<https://atrobushing.com/documents/Freightliner-Guide-2023.pdf>)

ATRO Product Spotlights (<https://atrobushing.com/tech-docs/atro-tdocs-product-spotlights>)

Suspension Schematics (<https://atrobushing.com/ProductListFilter?sCat1ID=SuspensionSystems>)

The ATRO Warranty (<https://atrobushing.com/tech-docs/atro-tdocs-warranty>)

One Torque Rod Works Around the Clock

ATRO's Rotating Pin

- Allows 360° of movement, allowing one torque rod to fit any clocking angle, reducing inventory
- Faster, easier installation
- Eliminates Bushing Wind Up
- Reduces stress on the entire suspension
- Longer Life = Less Downtime

Torque Rod: Product Spotlight

ATRO

Product Spotlight

PS001-010124

1/1/2024

ATRO's Rotating Pin Torque Rod Bushing

Better engineering. Faster, simpler installation.

ATRO's innovative torque rods have rotating pins with custom engineered polyurethane bushings. They install easier and last longer than competitor parts. No dry out, no corrosion, no wind up.

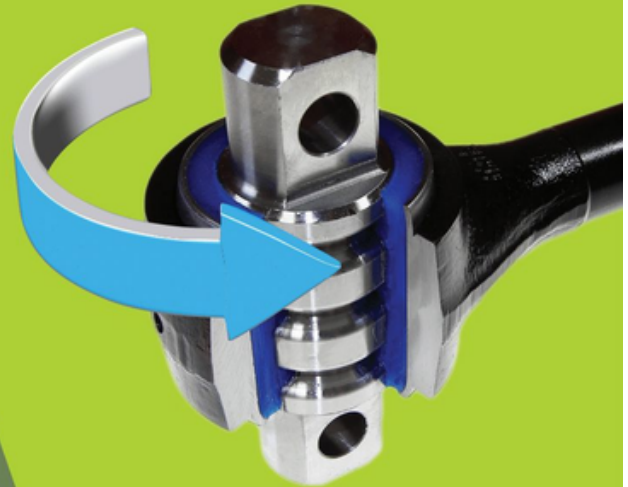

The ATRO torque rod pin can rotate a full 360° and adjust to any clocking angle for fast, easy installation.

ATRO parts outperform rubber parts by 3-5 times.

- ATRO polyurethanes are 3-5 times stronger than rubber.
- Resistant to oils, grease, road salt, and other chemicals.
- Specific compounds optimize the performance of each part.



Find the rod you need fast with ATRO's Torque Rod Finder.

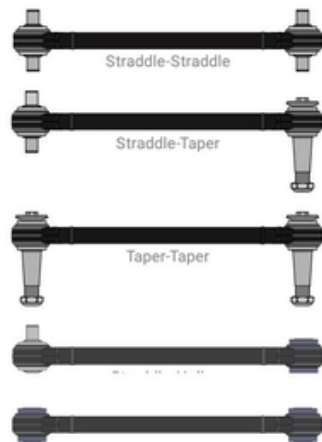

Save time and cost with ATRO Torque Rods.

- Less inventory: one rod fits any clocking angle.
- Eliminates bushing wind up (typical with rubber).
- Reduces stress on the ENTIRE suspension.
- Longer life reduces customer's operating costs.

Available configurations:

- Large-Eye Torque Rods
- Small-eye Torque Rods
- Two-Piece Torque Rods
- V-Rods
- Custom Rods



ATRO Parts. Performance that drives your success.

ATRO, LLC | 6 Bolte Lane | St. Clair, MO 63077 USA | Phone (800) 325-6114

www.atrobushing.com

© 2024 ATRO, LLC

Top Movers - Suggested Stocking Lists

FREIGHTLINER SUGGESTED STOCK

ATRO Part #	Description	OEM #	Qty
CR00-67661	1810 Carrier Bearing Self Aligning	10094142	2
CR00-67825	1810 Carrier Bearing	210661-1X	2
CM46-61001	Cab Mount Kit	681890001, 6818910001	1
EM46-69100-HT	Exhaust Mount Hi Temp	CBA12 100	2
HL46-64435	FLD120 Hood Latch	17-12435-00	1
HL46-64480	FLD120 Hood Latch Kit With Catch	17-12438-00	2
LP46-19773	M2 Spring Pad	A1615303000	2
MM46-62000-HT	Mount Kit	BCD 27330 1, BCD27330 2, BCD 28805 1	1
MM46-62005-HT	Mount Kit	BCD26704-1,BCD27651-1,BCD28945-1	1
MM46-62006-HT	Engine Mount Kit Front	LORSSB33, SSB3310018	1
MM46-62417-HT	Motor Mt Rear	LORJ20941, LORJ209417 FLD112	1
MM46-62418-HT	Engine Mount Kit Rear	LOR J20941-3-6	1
MM46-62650-HT	Engine Mount Hi Temp	CBA24 650 50A	1
PB46-26268	Pivot Bushing Anti-Walk	16-16412-000, 16-18035-000	4
PL1015-HT	Radiator, Motor Mount-High Temp	J7165-1 r	4
PL1133	Hood Roller (Set Of 2)	J17700-5	1
SP46-11023	Spring Eye Bushing	16-18023-000	2
SP46-11473	Spring Eye Bushing	16-16473-000	2
SP46-52800	Spring Eye Bushing	680-322-01-50	2
TM46-63529-HT	Transmission Mount, Auxiliary Hi Temp	CBC 35 2 9	2
TM46-63664-HT	Transmission Mount Hi Temp	J6256 64	2
TR46-41000	Airliner Torque Rod	16-15632-000	1
TR46-41002	FASII Torque Rod	16-16749-002	1
TR46-41316	FASII Torque Rod	16-16749-000	1
TR46-41716	FASII Torque Rod	16-16749-001	1
TR46-49002	TufTrac Torque Rod	16-15002-000, 16-15002-001	1

ATRO With ATRO behind you, **drive forward.**
 SUSPENSION | TRAILER | STEERING | TORQUE ROD | UNDERCAB/HOOD | SERVICE PARTS | TOOLS

6 Bolte Lane
 St. Clair, Missouri 63077 • U.S.A.
 800.325.6114 • Fax 866.920.2005
ATRObushing.com

©2023 ATRO, LLC.

ATRO, LLC. is not liable for any errors herein. All manufacturers' names and part numbers are used without permission; no endorsement, affiliation, or recommendation is implied. They are included for reference purposes only.

ALL MAKES SUGGESTED STOCK

ATRO Part #	Description	Make/Catagory	OEM #	Qty
KT50-25003	Hendrickson Haulmaax Overhaul Kit	Hendrickson		2
KT62-62216-HT	Mack Transmission Insulator Kit	Mack	204SX216	1
KT62-62389-HT	Fuller - Allison Insulator Kit	Mack	204SX389	1
MM62-622M2-HT	Engine Mount Kit	Mack	25164179	1
SK62-50340	Mack Insulator Pad Kit	Mack		1
SK62-50380	Mack Insulator Pad Kit	Mack		1
TR62-41180	Torque Rod	Mack	25162529	1
TR62-413M2	Torque Rod	Mack	25170832	1
MM55-62005-HT	Engine Mount Kit Rear	Navistar	1664729C1	2
PL1055-HT	Motor Mount	Navistar	470031C2	1
TR55-418C1	Torque Rod	Navistar	3580088C1, 5015565C2	1
TR55-428C1	Torque Rod Corporate Air	Navistar	3580088C2	2
KT59-62003-HT	Motor Mount Kit	Kenworth	K066-404, K066-406	1
KT59-62004-HT	Motor Mount Kit	Kenworth	K066-377, K066-421	1
PL1011-HT	Hood Pin	Kenworth	K179-528	2
TR59-41375	Torque Rod	Kenworth	944270	1
TR59-41474	Torque Rod	Kenworth	K195-474	1
CM75-61257	Cab Sleeper Mount	Peterbilt	20-08257	1
EM75-69000-HT	Exhaust Mount	Peterbilt	M13-6001	1
EM75-69096-HT	Exhaust Mount	Peterbilt	13-03096	1
EM75-69656-HT	Exhaust Mount	Peterbilt	14-14656	2
HM75-64726	Hood Mount Pivot Bushing	Peterbilt	13-04726, 13-04727	2
HM75-65510	Hood Bumper	Peterbilt	13-03510	2
HM75-66164	Hood Mount	Peterbilt	13-04164	1
MM75-62001-HT	Engine Mount Kit Rear	Peterbilt	CB2203-72	2
PL1018-HT	Engine Mount	Peterbilt	05-10197	2
PL1070-HT	Engine Mount	Peterbilt - Kenworth	05-08968, M501	2
TR00-41009	Torque Rod	Peterbilt - Kenworth	C65-6009, C65-6020	1
TR75-41059	Torque Rod	Peterbilt	03-04059	1
TR75-41108	Torque Rod	Peterbilt	03-05108	1
TR75-41327	Torque Rod	Peterbilt	C65-6016-000010440	4

ATRO With ATRO behind you, **drive forward.**
 SUSPENSION | TRAILER | STEERING | TORQUE ROD | UNDERCAB/HOOD | SERVICE PARTS | TOOLS

6 Bolte Lane
 St. Clair, Missouri 63077 • U.S.A.
 800.325.6114 • Fax 866.920.2005
ATRObushing.com

©2023 ATRO, LLC.

ATRO, LLC. is not liable for any errors herein. All manufacturers' names and part numbers are used without permission; no endorsement, affiliation, or recommendation is implied. They are included for reference purposes only.

US Area Sales Managers & Contact Information

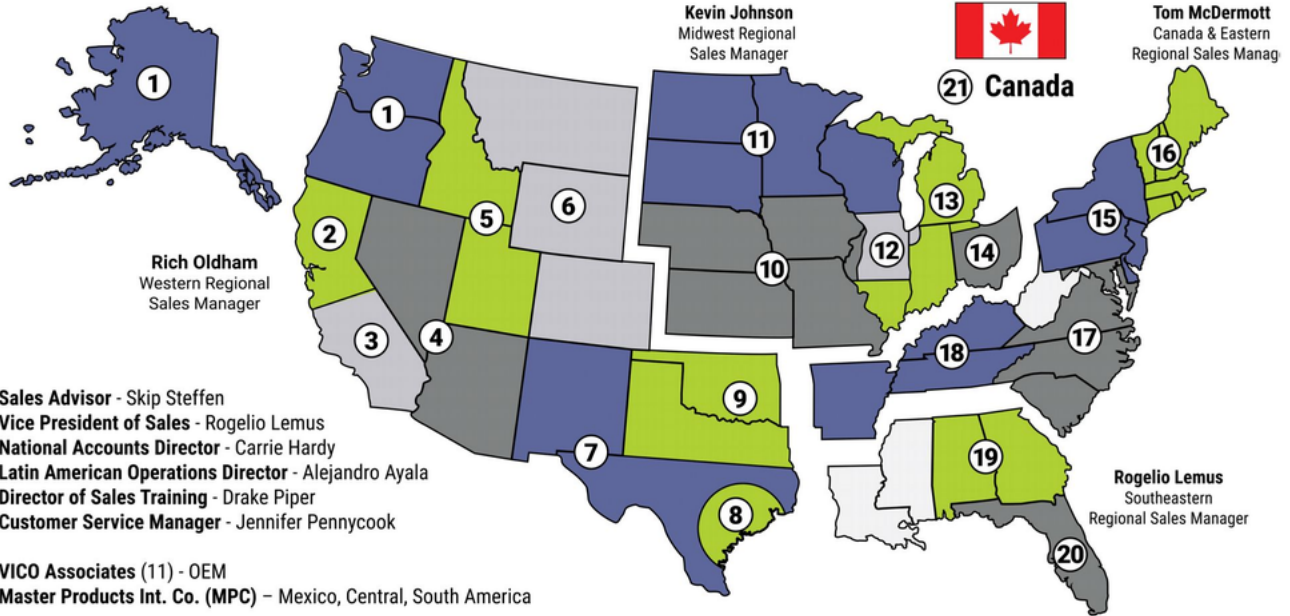

ATRO Parts. Performance that drives your success.

ATRO, LLC | 6 Bolte Lane | St. Clair, MO 63077 USA | Phone (800) 325-6114

www.atrobushing.com

© 2024 ATRO, LLC

Territory	Sales Contacts	Title	Phone Number	Email Address
West	Rich Oldham	Western Regional Sales Manager	(937) 416-4020	roidham@atrobushing.com
1	Luba Brodaskaia	Area Sales Manager: AK, OR, WA	(425) 922-8282	lbrodaskaia@atrobushing.com
2	Michael Evans	Area Sales Manager: North CA	(916) 597-3526	mevans@atrobushing.com
3	Doug Amaya	Area Sales Manager: South CA	(909) 264-0616	damaya@atrobushing.com
5	Jace Peterson	Area Sales Representative: ID, UT	(801) 259-6701	jpeterson@atrobushing.com
7	Peter Aguilar	Area Sales Manager: NM, South TX	(915) 204-3920	paguilar@atrobushing.com
9	Luis Quiroga	Area Sales Manager: OK, North TX	(602) 568-3343	lquiroga@atrobushing.com
Midwest	Kevin Johnson	Midwest Regional Sales Manager: Region	(419) 410-6945	kjohnson@atrobushing.com
10	Tom Callahan	Area Sales Manager: IA, Northwest IL, KS, MO, NE	(913) 225-2902	tcallahan@atrobushing.com
11	Chad Mecl	Reese Company: MN, ND, SD	(651) 249-8774	chadmecl@me.com
	Brad Hesse	Reese Company: WI	(847) 274-5539	bradhesse@gmail.com
12	Brian Jerome	Area Sales Representative: Chicagoland	(847) 529-1949	bjerome@atrobushing.com
13	Kevin Johnson	Regional Sales Manager: South IL, IN, KY, MI, Northwest OH	(419) 410-6945	kjohnson@atrobushing.com
14	Samuel Pusateri	Area Sales Representative: OH	(330) 280-2356	spusateri@atrobushing.com
East	Tom McDermott	Canada & Eastern Regional Sales Manager	(617) 968-2407	tmcdermott@atrobushing.com
15	Adam Castoldi	Area Sales Manager: DE, NJ, PA, NY	(252) 571-3719	acastoldi@atrobushing.com
16	Tom McDermott	Regional Sales Manager: CT, MA, ME, NH, RI, VT	(617) 968-2407	tmcdermott@atrobushing.com
17	Chris Rebmann	Area Sales Manager: MD, NC, SC, VA	(309) 868-9745	crebmann@atrobushing.com
18	Bill Halliburton	Area Sales Manager: AR, KY, TN	(615) 559-7811	bhalliburton@atrobushing.com
Southeast	Rogelio Lemus	Southeastern Regional Sales Manager	(248) 207-2469	rlemus@atrobushing.com
20	Amanda Delaney	Area Sales Manager: FL,	(727) 564-4745	adelaney@atrobushing.com
Canada	Tom McDermott	Canadian & Eastern Regional Sales Manager:	(617) 968-2407	tmcdermott@atrobushing.com
21	Ryan Fritsch	Canadian Sales Manager	(250) 575-3700	ryan@proforcecanada.ca

Sales Support	Title	Phone Number	Email Address
Skip Steffen	Sales Advisor	(573) 290-4002	ssteffen@atrobushing.com
Rogelio Lemus	Vice President Sales	(248) 207-2469	rlemus@atrobushing.com
Carrie Hardy	National Accounts Director	(989) 450-0725	chardy@atrobushing.com
Alejandro Ayala	Director of Latin Operations	(989) 395-2345	aayala@atrobushing.com
Drake Piper	Director of Sales Training	(989) 928-2531	dpiper@atrobushing.com
Dawn Peters	Training and Development Specialist	(517) 304-7272	dpiper@atrobushing.com
Julie Marchard	Training and Development Specialist	(512) 663-6430	jmarchard@atrobushing.com
Jennifer Pennycook	Customer Service Manager	(573) 290-4001	jpennycook@atrobushing.com



Sales Representatives July 2024

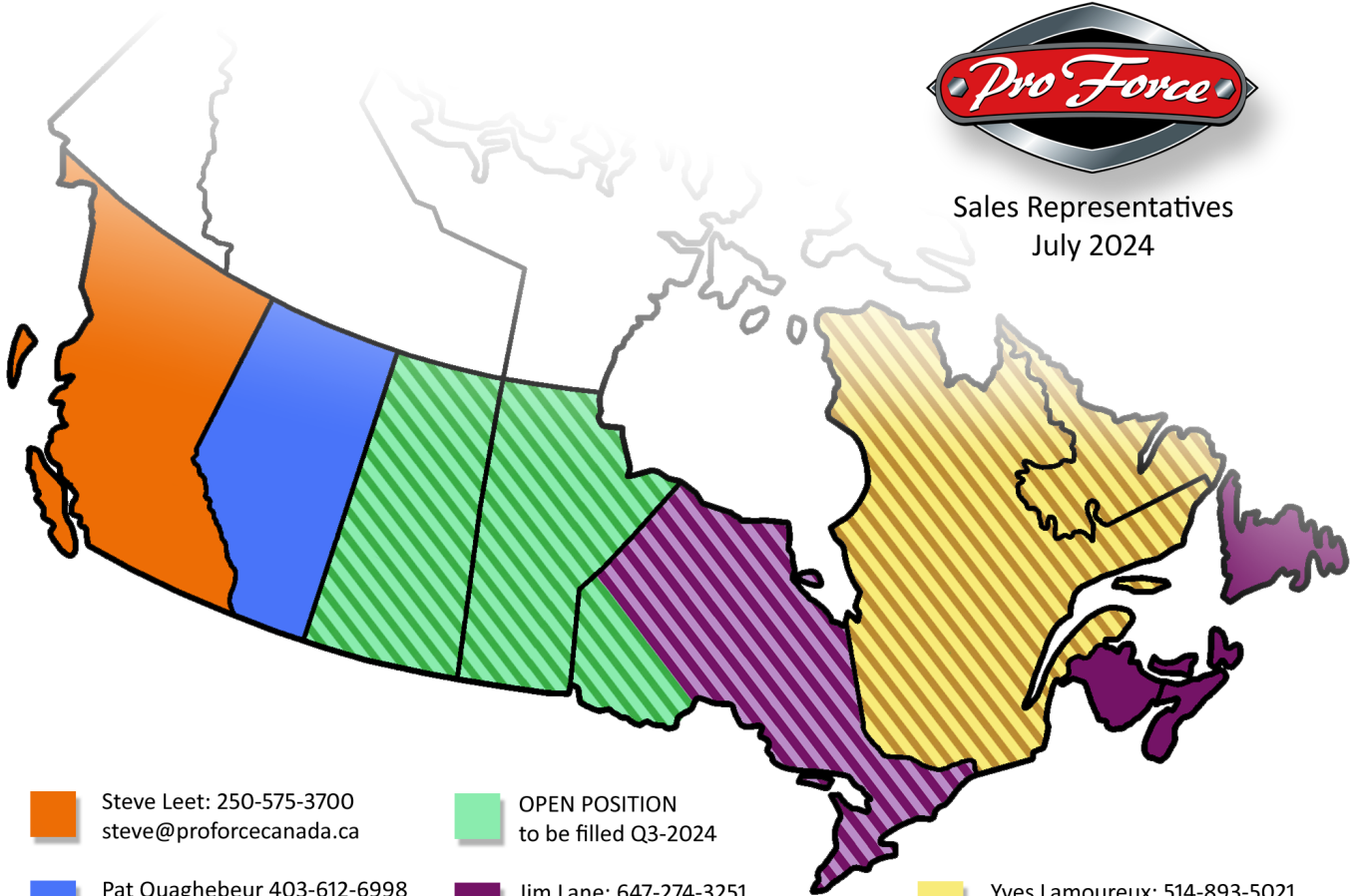



 Steve Leet: 250-575-3700
steve@proforcecanada.ca

 Pat Quaghebeur 403-612-6998
pat@proforcecanada.ca

 Ryan Fritsch: 204-292-8370
ryan@proforcecanada.ca

Tracey Toews: 204-298-3937
Customer Service
tracey@proforcecanada.ca

 OPEN POSITION
to be filled Q3-2024

 Jim Lane: 647-274-3251
jim@proforcecanada.ca

 Dave McLellan: 647-271-0345
dave@proforcecanada.ca

Chuck Fritsch: 204-291-2080
General Manager
chuck@proforcecanada.ca

 Yves Lamoureux: 514-893-5021
yves@proforcecanada.ca

 Lynda Gauvreau: 514-244-4121
lynda@proforcecanada.ca

Ryan Fritsch: 204-292-8370
Sales Manager
ryan@proforcecanada.ca

General Product Information

Customer & Technical Support

ATRO Engineered Systems
6 Bolte Lane
St. Clair, MO 63077 USA

Phone: **(800) 325-6114**

Fax: (866) 920-2005

Email: CustomerService@atrobushing.com

Monday through Friday: 8:00 am – 4:30 pm U.S. Central Time

Warranty Information



Industry's Best Warranty

Our confidence is your confidence. You can count on ATRO parts to run better, and last longer.

We're so confident in the engineering, design, and quality of our products, that we back almost all of them with the industry's best warranty.

Three Years.

ATRO DOMESTIC WARRANTY POLICY

ATRO products are covered by a **3 Year Parts Warranty** with the following exceptions:

Small eye torque rods (2" ID)	2 year
SKB Series Bronze Bushing King Pin Kits	2 year
Equalizer beams	1 year
LP50/KT50 series for Hendrickson HN/Haulmax	1 year
MS99 Series Gripper Pads and Rollers	1 Year
MS99-69779 and MS99-69780 Bumper Pads	no warranty
SKC Series Individual King Pin Components	no warranty
Tools	no warranty

The ATRO Warranty (<https://atrobushing.com/tech-docs/atro-tdocs-warranty>)

Last updated: Monday, 14 August 2023 04:24 PM

[^Back to Top](#)

Copyright © Daimler Truck North America LLC. [Privacy Statement, Legal Notices and Terms](#) (<https://daimler-trucksnorthamerica.com/privacy-policy>).

All rights reserved. Daimler Truck North America LLC is a [Daimler](http://www.daimler.com/) (<http://www.daimler.com/>) company.